



PRODUCT CATALOGUE

Issue 1

....we are committed to serve since 2007

G-Tech Limited

Mukono-Kayunga Road

Block 149, Plot 1105

(after Mpoma Satellite Station)

P.O.Box 903, Mukono, Uganda.

Tel: +256 706 559 028 / +256 392 174 934

Mob: +256 752 735 200 / +256 782 069 922

Email: admin@gtechlimited.com /

gtechlimited07@gmail.com

website: www.gtechlimited.com

CONTENTS

About us.....	1
Castor Wheels.....	2
Pneumatic Fittings.....	3
Pipe Clamps.....	4
MS, GI & SS Pipes & Fittings.....	5
Valves.....	6
Bearings.....	7
Industrial Chains, Sprockets & Idler Wheels.....	8
Assorted Screws, Bolts, Nuts & Washers.....	9
Water Meters.....	10
Industrial Water Guns & Hose.....	11
Life Line, Hooks & Tensioners.....	12
Vee Belts, Coupling & Circlips.....	13
Escalators Spares.....	14
Gravity & Power Rollers.....	15
Punel Keys, Grease Guns & Welding Rods.....	16
Safety.....	17
Mechanical Seals.....	18
Anti-climb Fence & Spikes.....	19
Wear Strips & Levelers/Articulated Foot.....	20
Stonex Products.....	21
Conveyor Belt, Gear Box & Drive Motors.....	22
Slate Chains & Magnetic Curves.....	23
Lubricants.....	24
Installation & Maintenance of.....	25
<i>industrial and manufacturing, Airport baggage handling systems, elevators and escalators</i>	
Building Construction & Civil Works.....	26
Accreditation & Certificates.....	27

About Us

G-TECH LIMITED

WE ARE COMMITTED TO SERVE SINCE 2007

G-TECH Ltd is a Technical Services Company that provides Industrial machinery installation, Maintenance, General industrial workshop services; Supply of Industrial spares, Civil Works including Building Construction and Maintenance.

We are dedicated to deliver value for money services, works and supplies in a timely manner to our clients through global expertise and local knowledge.

With a professional team of engineers, technicians, artisans, quality assurance specialists, economists, finance professionals, we continue to serve and grow both in capacity, capability and precision towards shared benefit with our clients and stakeholders.

OUR PROMISE

We will provide unequalled value to our customers while adding value growth to stakeholders.

OUR VALUES

- Integrity
- Professionalism
- Consistency
- Innovation
- Team work
- Customer service

CONTACT US

G-Tech Limited
Mukono-Kayunga Road
Block 149, Plot 1105

(after Mpoma Satellite Station)
P.O.Box 903, Mukono, Uganda.

Tel: +256 706 559 028 / +256 392 174 934

Mob: +256 752 735 200 / +256 782 069 922

Email: admin@gtechlimited.com / gtechlimited07@gmail.com

website: www.gtechlimited.com



Administration staff



Artistic impression of G-Tech Limited Warehouse



G-Tech Limited Offices



Toolbox meeting

© G-Tech Limited
Designed by Ahimbisibwe Michael



Castor Wheel

All sizes

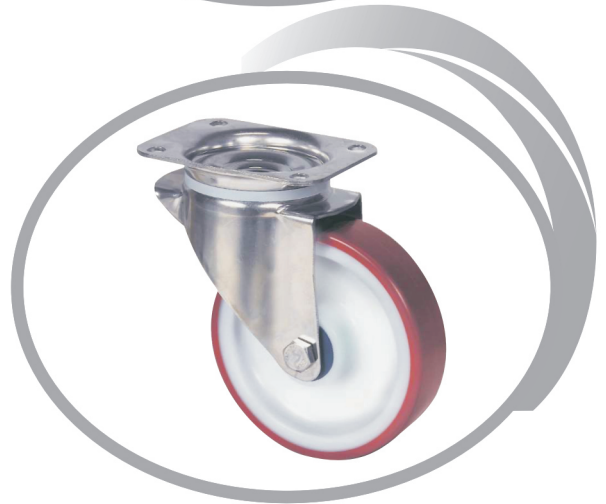

Pneumatic Fittings

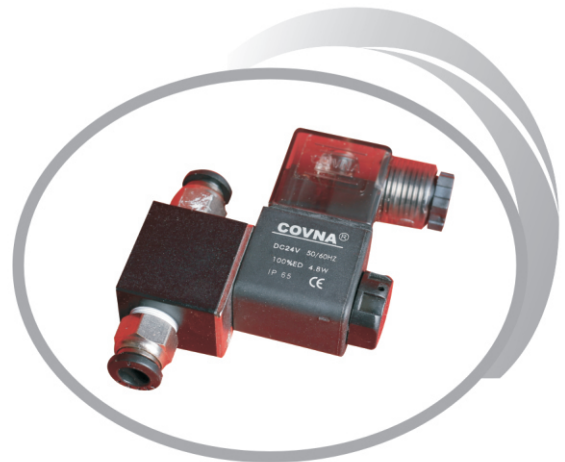
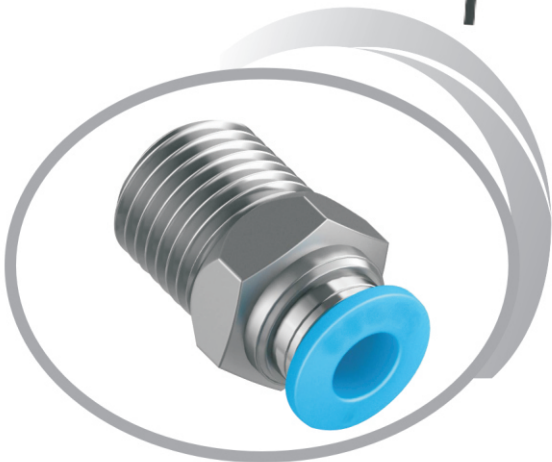
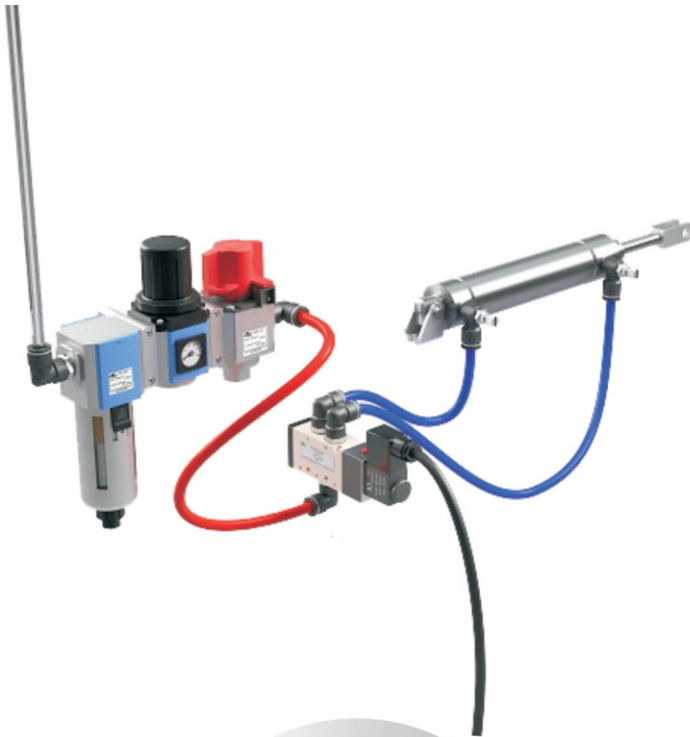

Pipe Clamps

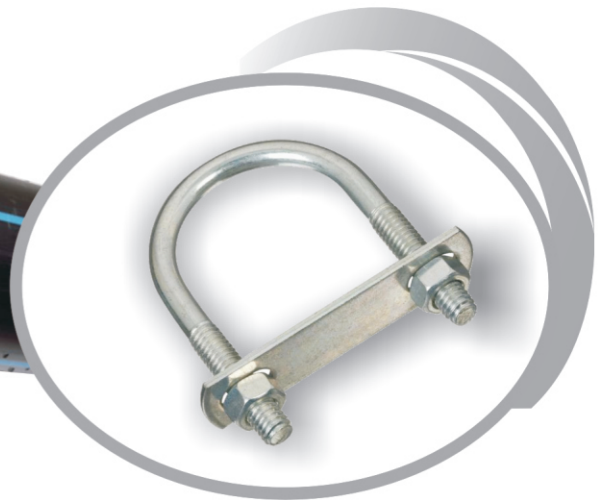
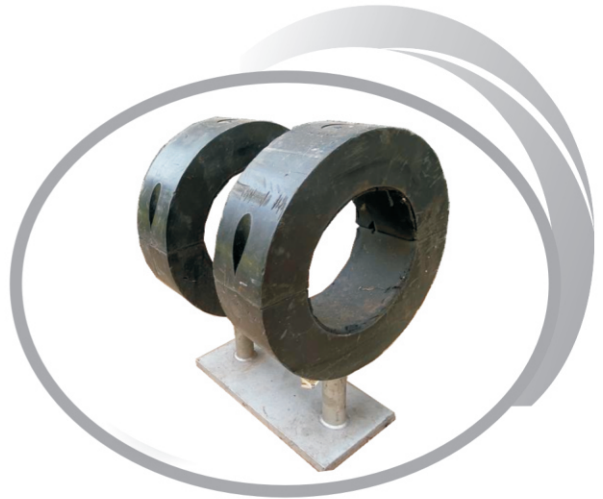

MS, GI & Pipes Fittings

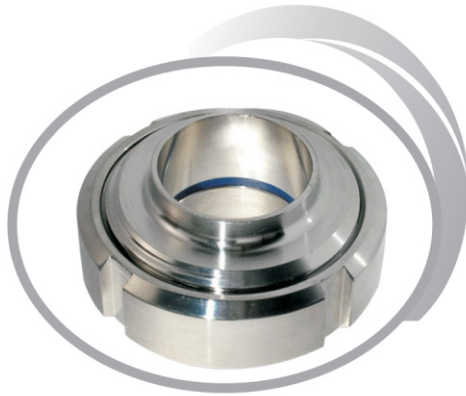

Valves

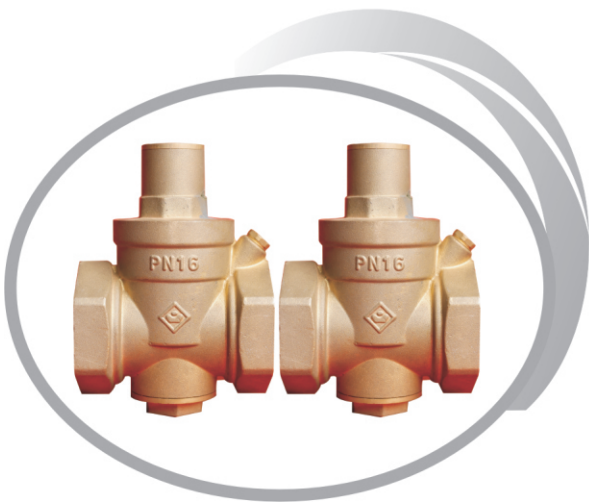
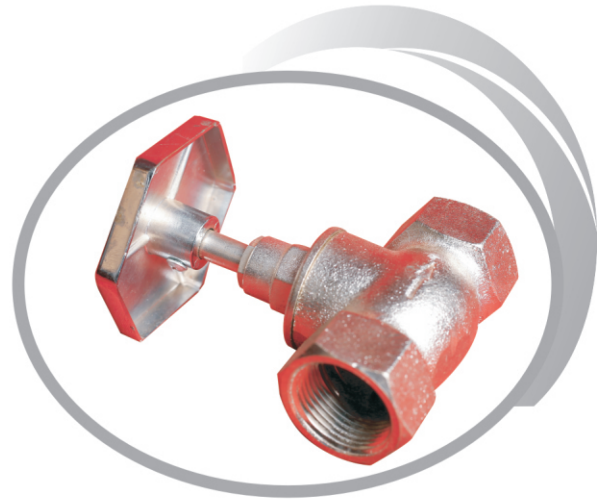

Bearings

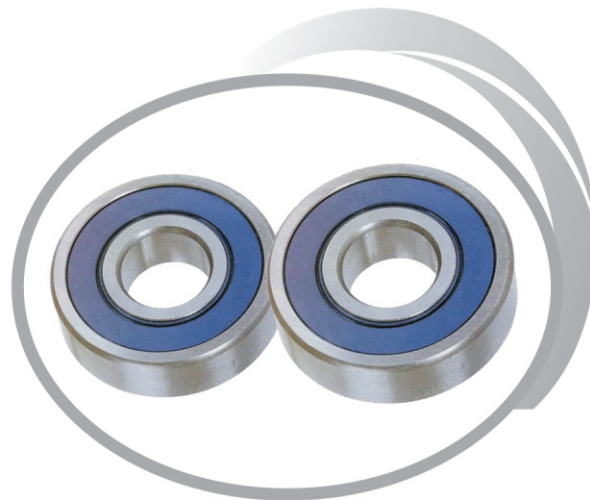
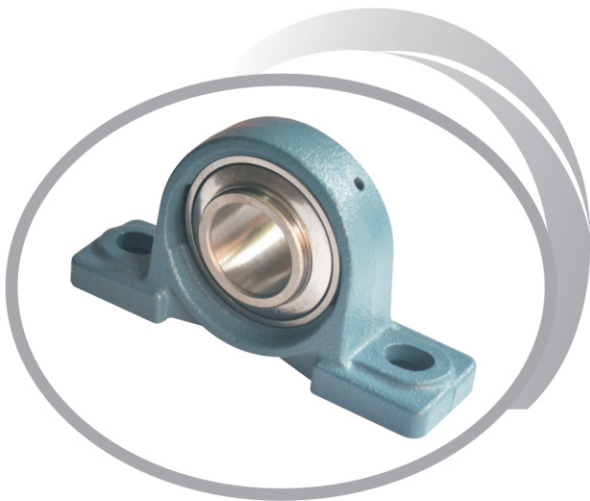

Industrial Chains, Sprockets & Idler Wheels



Assorted Screws, Bolts, Nuts & Washers

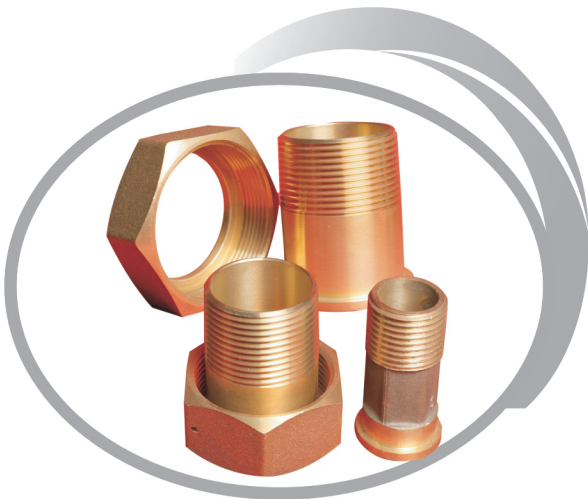

Water Meters

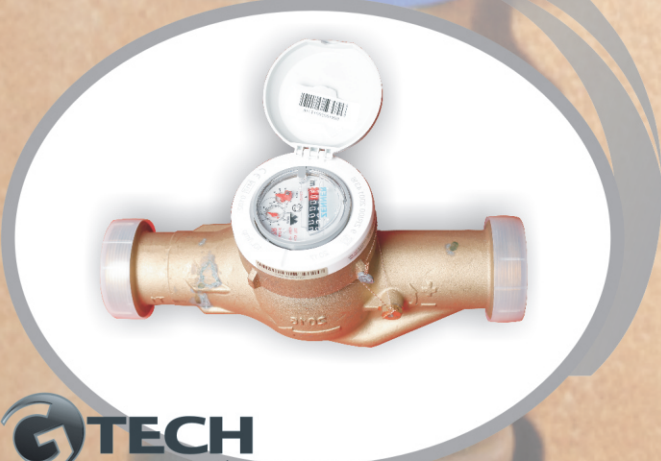
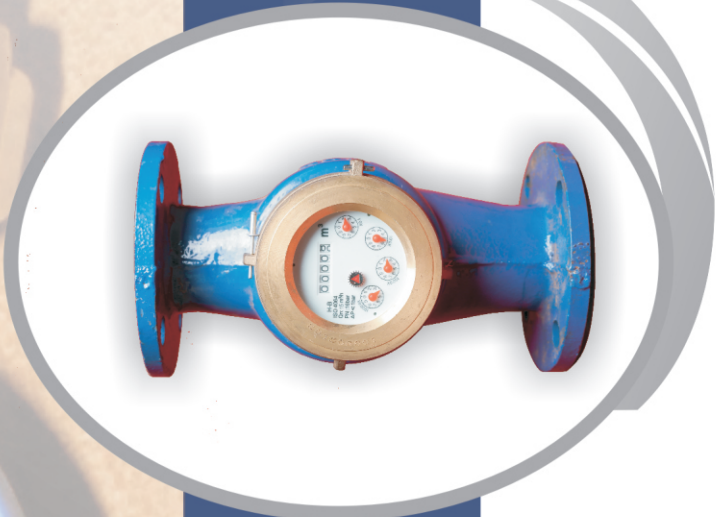

Industrial Water Guns & Hose



Lifelines, Hook & Tensioners

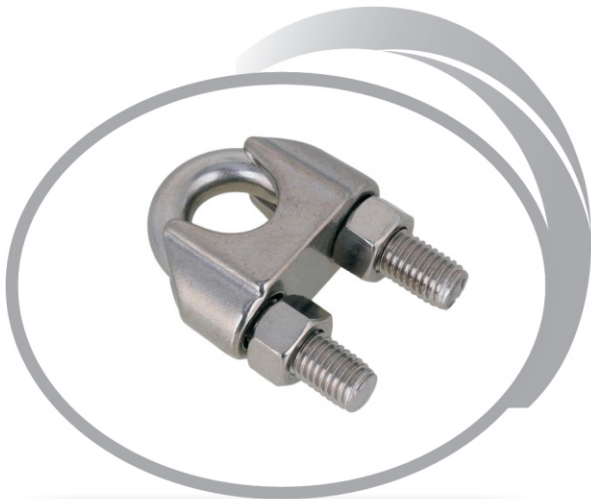

Vee Belts, Couplings & Circlips

Vee belts

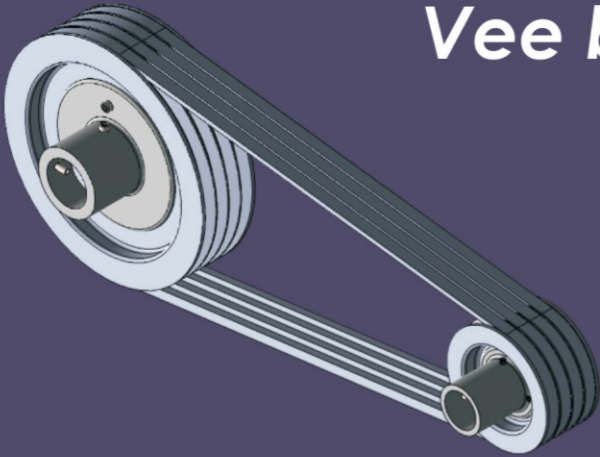

Couplings

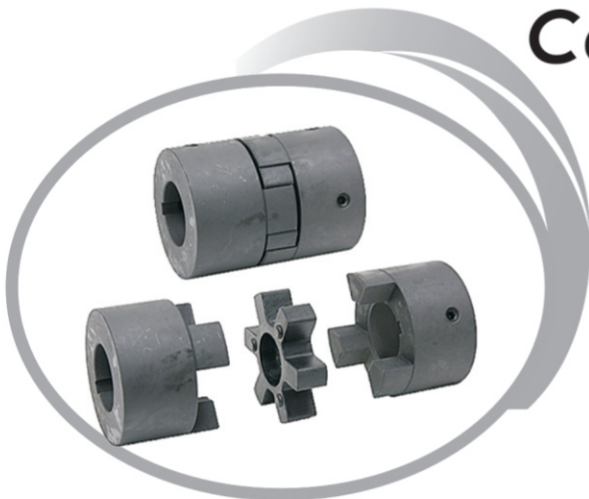

Circlips



Escalator Spares

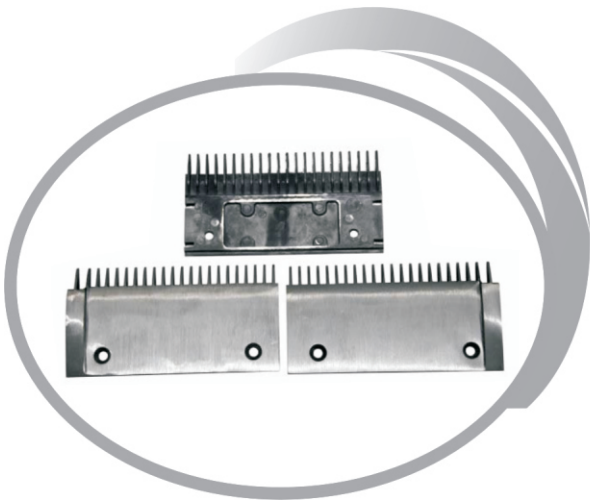
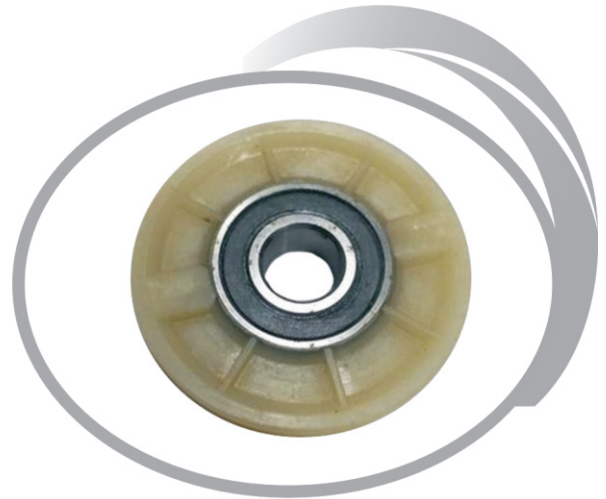
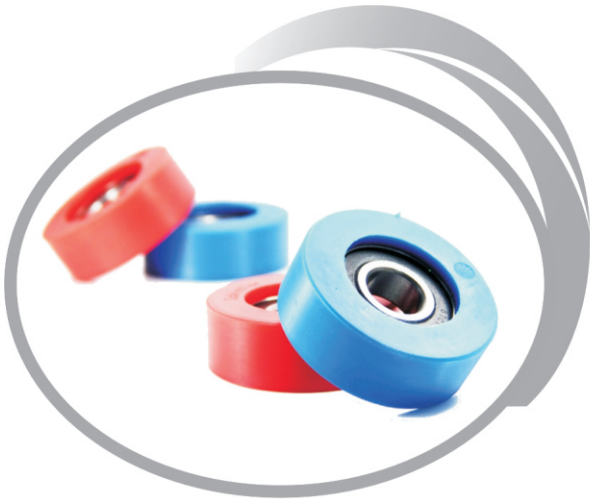
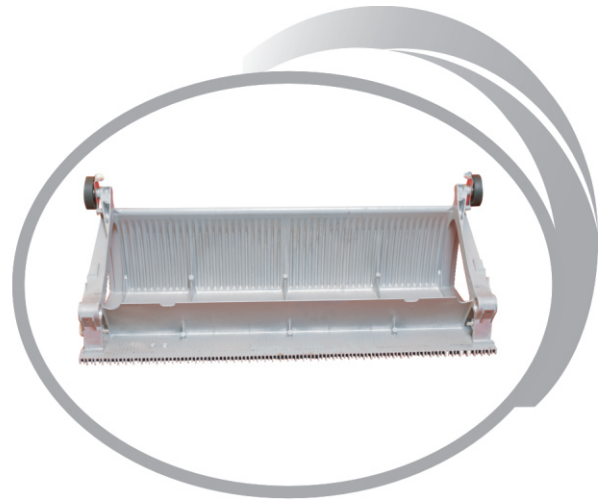
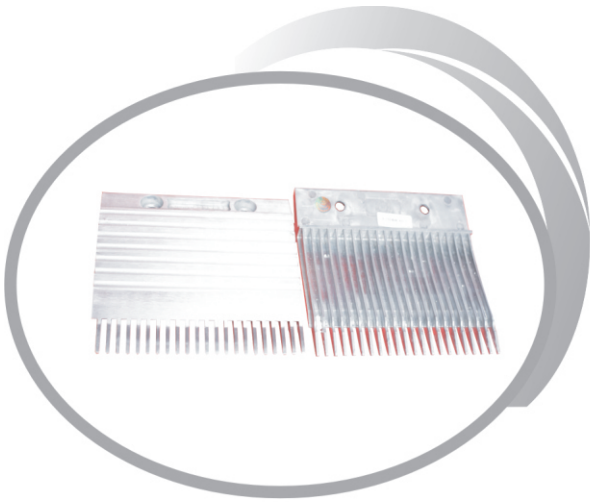

Gravity & Power Rollers

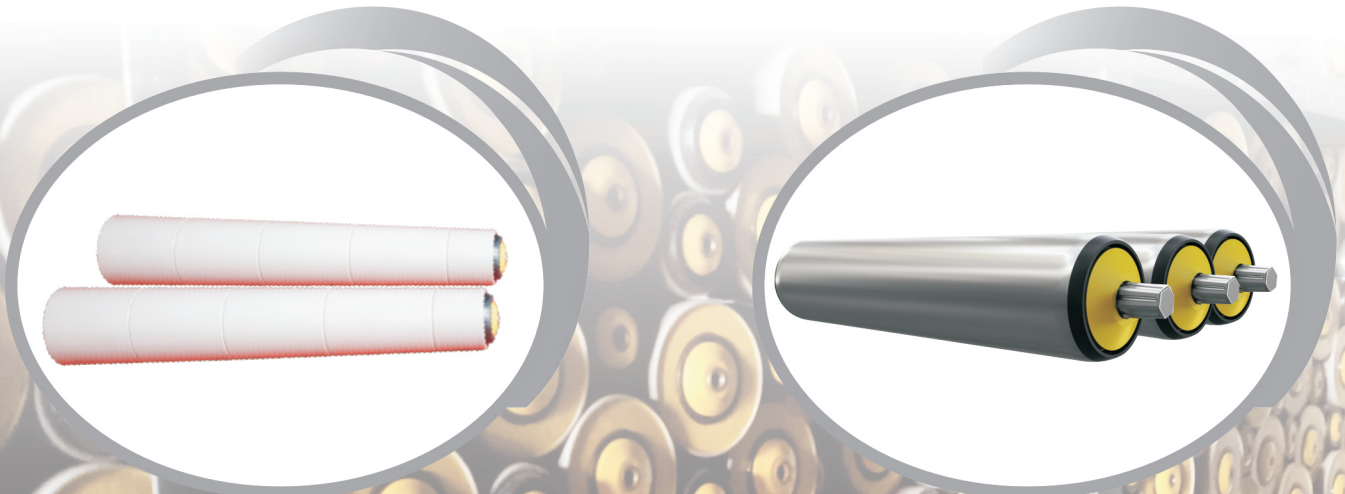
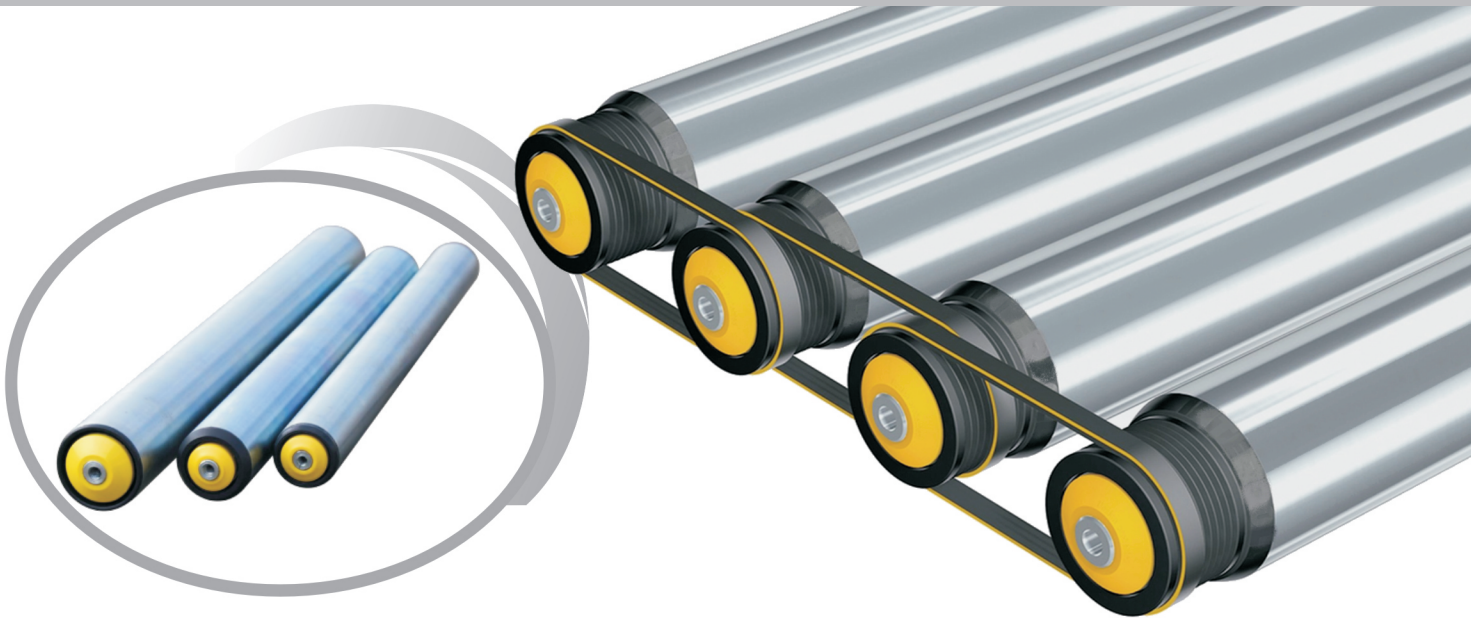

Punel Keys, Grease Gun & Welding Rods

PUNEL KEYS



GREASE GUN



welding rods



Safety

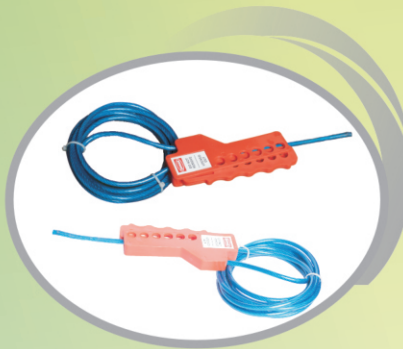

Mechanical Seals

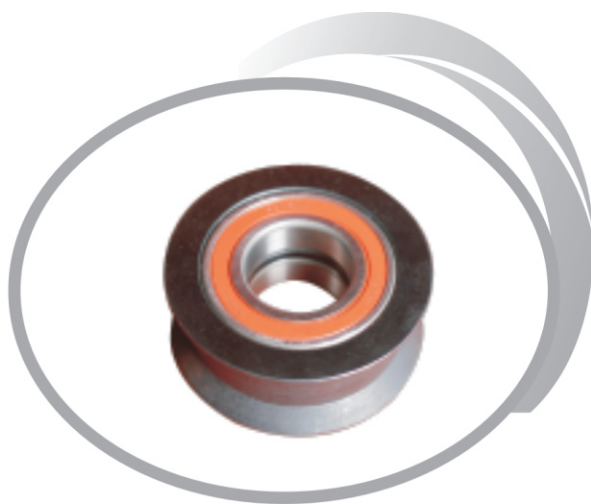

Anti-climb Fence & Spikes



SPIKES

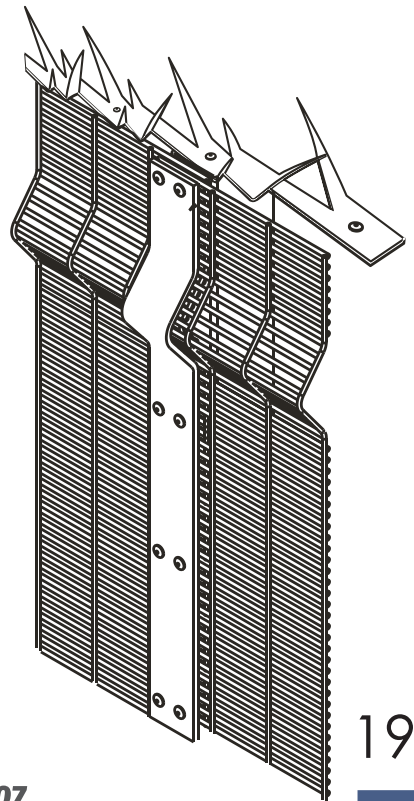

...we are committed to serve since 2007

Wear Strips & Levelers/Articulated Foot

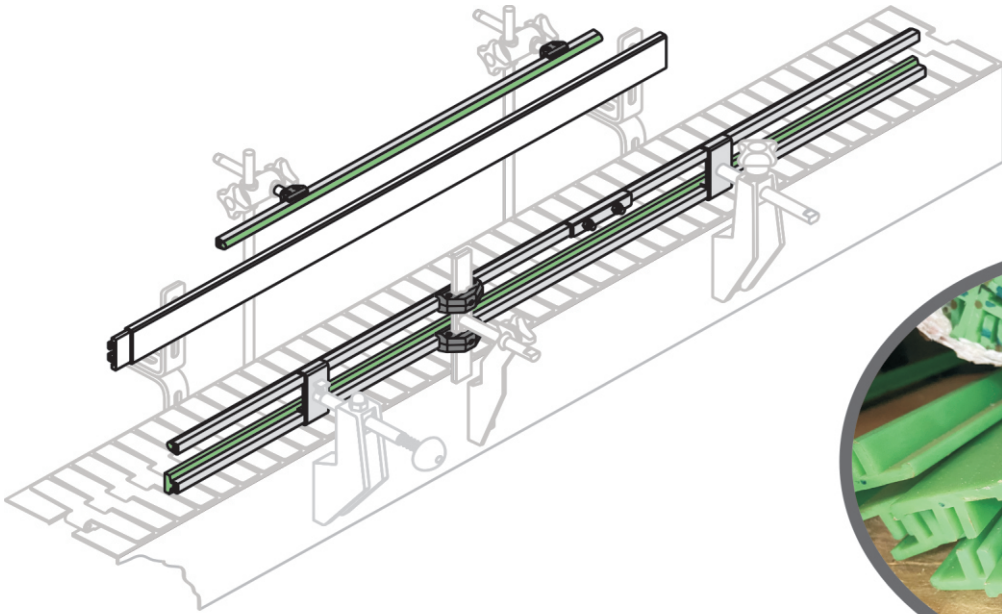

LEVELERS/ARTICULATED FOOT





Android Rugged tablet



High technology total stations



3D Laser scanners



GNSS Recivers



Tripods Fixed & Rotating 360 Degrees

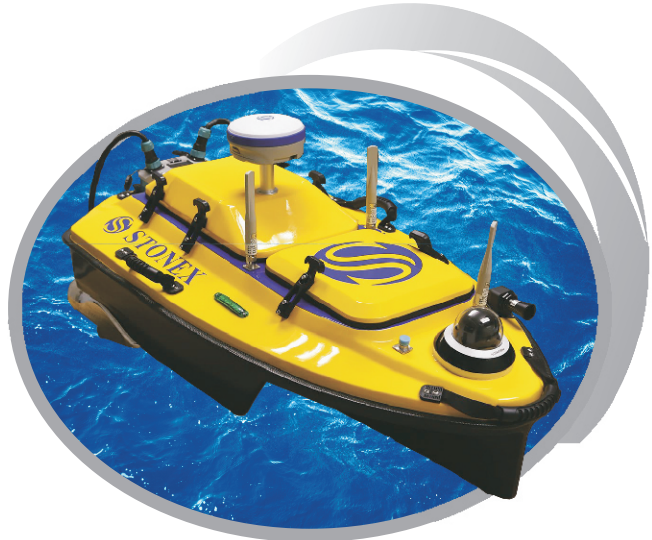

Unmanned Surface Vessel Solution

Conveyor Belt, Gear Box & Drive Motors

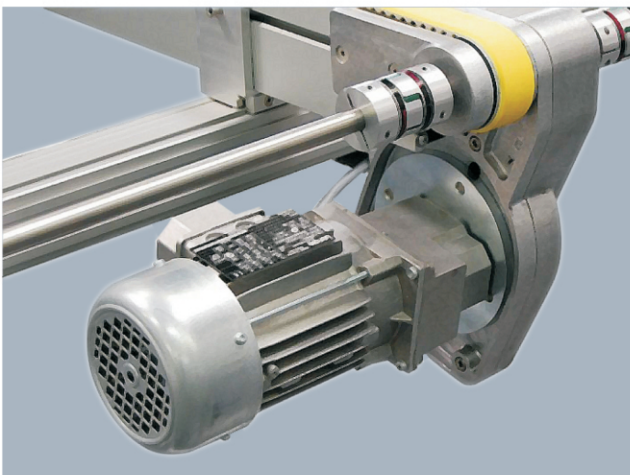
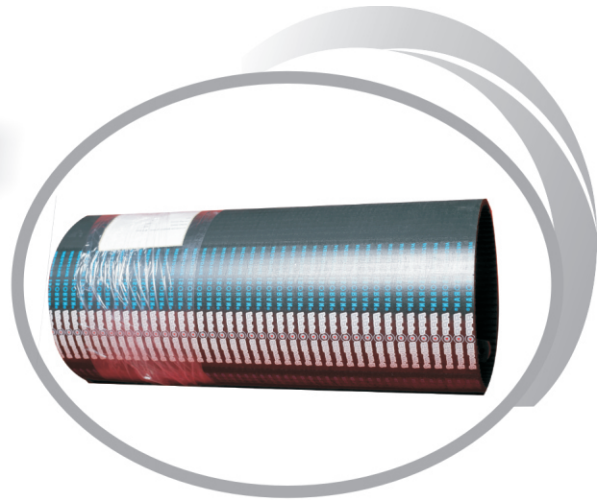
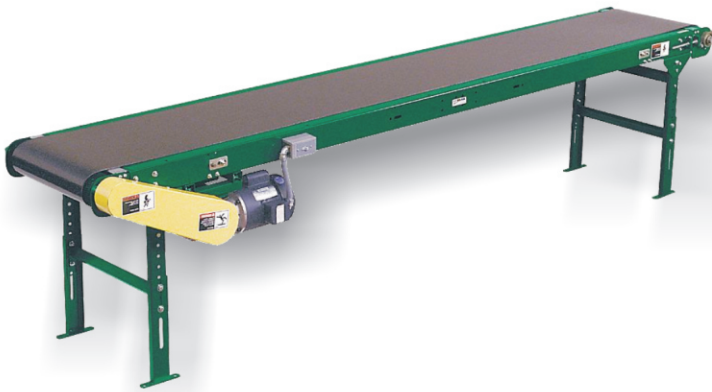

Slate Chains & Magnetic Curves

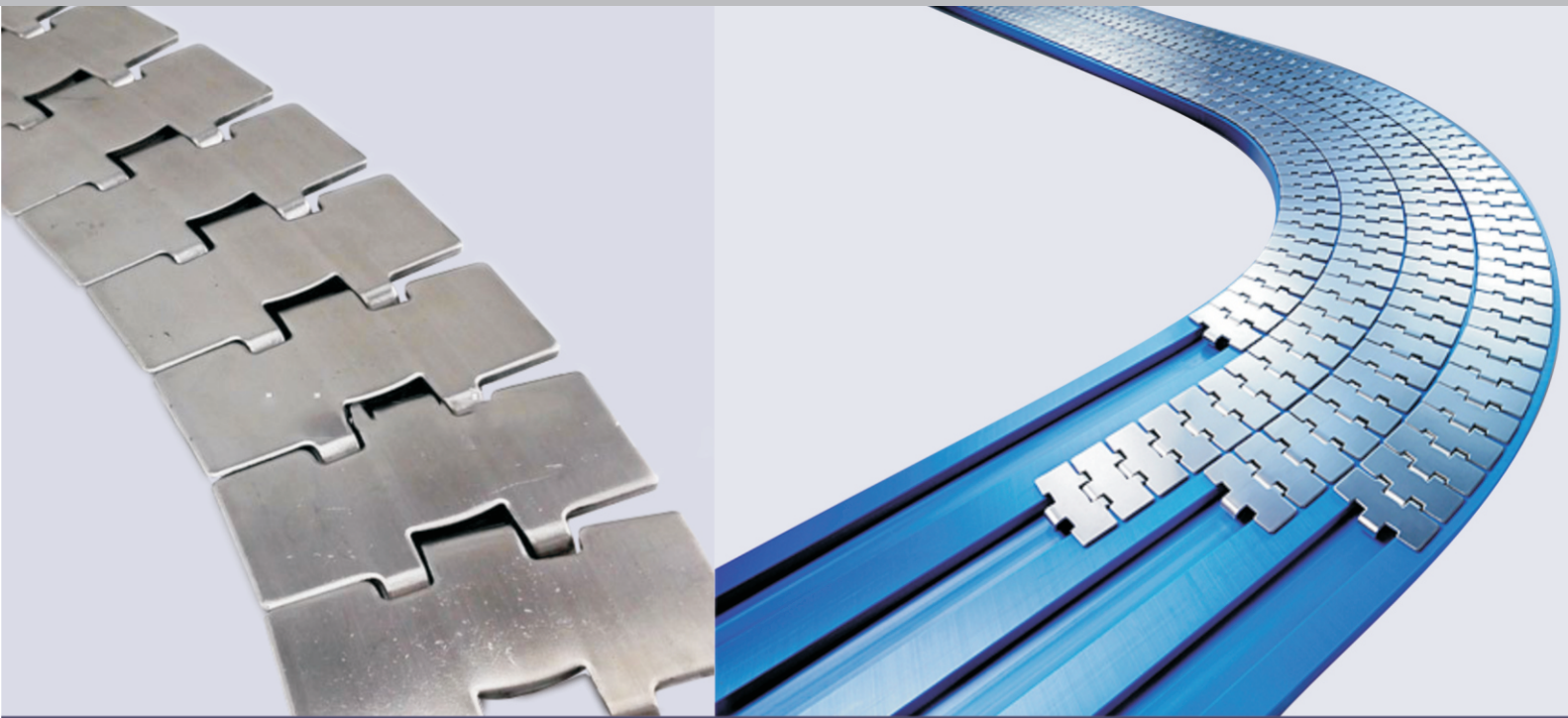

Lubricants

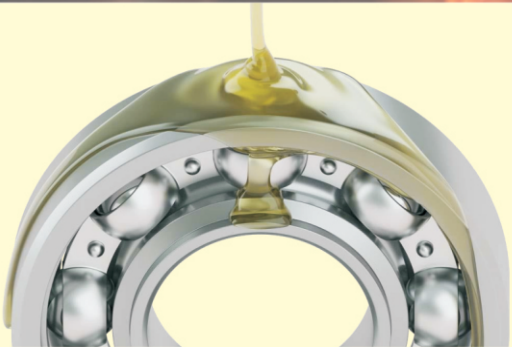

Instillation & Maintenance of

- . Industrial and Manufacturing Machinery
- . Airport Baggage Handling Systems
- . Elevators and Escalators



WE PAY attention

Building Construction & Civil Works



DETERMINED to deliver



Accreditation & Certification



Authorized Distributor of the following Brands



VANDERLANDE

Certifications



Membership

